



SLANETRAC

HT 1000

Equipment User
& Maintenance Manual



Honda GX390



Tel:00353 4690 24858
Email slanetracsales@gmail.com

SLANETRAC LIMITED

Equipment manufactured by:

SLANETRAC ENGINEERING LIMITED.
DEANHILL,
HAYES,
NAVAN,
CO. MEATH,
IRELAND.

Tel. +353 (0)46 9024858

Authorised Agent:

.....
.....
.....
.....
.....

Copy of Machine Identification:

The unit is fitted with plates which identify the machine and power unit. In order to ensure efficient technical assistance it is recommended that you record the numbers in this manual in the spaces below:

Machine type	<input type="text"/>
Machine identification number	<input type="text"/>
Year of manufacture	<input type="text"/>
Engine identification number	<input type="text"/>

INDEX

1. Introduction	5
2. Safety Notes	6
2.1 <i>Prepare for Safe Operation</i>	6
2.2 <i>Know Your Equipment</i>	6
2.3 <i>Danger, Warning, Caution</i>	7
2.4 <i>Use ALL Available Protective and Safety Devices</i>	8
2.5 <i>Checking the Equipment</i>	8
2.6 <i>Starting</i>	9
2.6.1 <i>Warn personnel before starting</i>	9
2.6.2 <i>Start safely</i>	9
2.6.3 <i>Follow recommended starting procedures</i>	9
2.6.4 <i>Test the controls</i>	9
2.7 <i>Work Safely</i>	9
2.7.1 <i>Making the right moves</i>	10
2.7.2 <i>Follow safe operating practices</i>	10
2.7.3 <i>Watch out for others</i>	10
2.8 <i>Safety Labels</i>	11
2.9 <i>Noise Level Label</i>	13
3. General Information	14
3.1 <i>Machine Description</i>	14
3.2 <i>Functional Elements on the Slanetrac HT 1000</i>	15
3.2.1 <i>Drive system</i>	16
3.2.2 <i>Skip</i>	16
3.2.3 <i>Engine</i>	16
3.2.4 <i>Hydraulic system</i>	16
4. Technical Specification	17
4.1 <i>Machine Dimensions – Weight – Contact Pressure</i>	17
4.2 <i>Machine Stability</i>	18
4.3 <i>Technical Data</i>	19
4.3.1 <i>Engine</i>	19
4.3.2 <i>Hydraulic System</i>	19
4.4 <i>Performance in Work</i>	20
5. Machine Controls	21
5.1 <i>Hydraulic Controls</i>	21
5.2 <i>Engine Controls</i>	25
6. User Instructions	26
6.1 <i>Operation of Machine</i>	26
6.2 <i>Engine Operation</i>	27
6.3 <i>Skip Operation</i>	27
6.4 <i>Transport</i>	27

INDEX

7. Machine Maintenance	29
7.1 <i>Introduction to Servicing</i>	29
7.2 <i>Tracks</i>	30
7.2.1 <i>Track Tension</i>	30
7.2.2 <i>Check Idler Rollers</i>	31
7.3 <i>Engine</i>	33
7.3.1 <i>Engine Oil Level</i>	33
7.4 <i>Hydraulic System</i>	34
7.4.1 <i>Oil</i>	34
7.4.2 <i>Filtration System</i>	35
7.5 <i>Skip High-Lift & Tipping Mechanisms</i>	36
7.6 <i>Approved Fuel, Oils and Lubricants</i>	36
7.6.1 <i>Fuel</i>	36
7.6.2 <i>Engine Oil</i>	36
7.6.3 <i>Track Drive Reduction Gears</i>	36
7.6.4 <i>Hydraulic Oil</i>	37
7.6.5 <i>Grease</i>	37
7.7 <i>Capacities</i>	38
7.8 <i>Handling of Waste Oils and Filter elements</i>	38
<i>Appendix – MAINTENANCE SCHEDULE</i>	39

1. INTRODUCTION

The purpose of this book is to enable the owner and/or driver to operate the equipment in a safe manner. Providing that the instructions are followed carefully the equipment should give years of service. When being supplied with the product by **Slanetrac Eng Limited** or their agents you have the opportunity to ensure that you understand the operating and maintenance instructions. Always consult **Slanetrac Eng Limited** or their agents if you do not understand any part of this book. It is important that these instructions are understood and observed.

When new parts are required it is important that only genuine service parts as supplied by **Slanetrac Eng Limited** or their agents are used. **Slanetrac Eng Limited** or their agents can give advice regarding their fitment and use. Extensive damage may occur as a result of the fitment of parts of inferior quality.

Owing to the wide variation in operating conditions, it is impossible for the company to make comprehensive or definitive statements in its publications regarding performance or methods of use of its machines, or to accept liability for any loss or damage which may result from these statements, or from any errors or omissions.

The equipment is designed solely for use as a Stand-on skip loader. Use in any other way is considered contrary to the intended use. **Slanetrac Eng Limited** or their agents accept no liability for any damage or injury resulting from misuse and these risks must be borne solely by the user. Compliance with, and strict adherence to, the conditions of operation, service and repair as specified by **Slanetrac Eng Limited** also constitute essential elements for the intended use. The equipment should be operated, serviced and repaired only by persons familiar with all their particular characteristics and who are acquainted with the relevant safety rules. Customers are strongly advised to use **Slanetrac Eng Limited** or an official agent in connection with any service issues.

In accordance with **Slanetrac Eng Limited's** policy of continuous improvement to its machines, alterations in the specifications of machines may be made at any time without notice. The company accepts no responsibility for discrepancies which may occur between the specifications of its machines and the descriptions thereof contained in its publications.

Safety

The safety of the operator is one of the major concerns in the design of the equipment. Designers incorporate as many safety features as is possible in the construction of the equipment. Accidents can occur which could have been avoided by a few seconds thought and a more careful approach to machine operation.

Read and practice the safety instructions detailed in this book.

2. SAFETY NOTES

2.1 Prepare for Safe Operation

Protect Yourself

Wear all the protective clothing and personal safety devices issued to you or called for by job conditions. Do not take chances!

You may need:

- A hard hat
- Safety goggles
- Hearing protection
- Foul weather or other protective clothing
- Reflective clothing
- Protective gloves
- Safety boots

DO NOT wear loose clothing, jewellery or other items and tie up long hair which could entangle in the controls or other parts of the machine.

2.2 Know Your Equipment

Know your equipment.

Know how to operate all controls on the machine and on any attachments.

Know the rated load capacity, speed range, braking and steering characteristics, turning radius, and operating clearances.

Keep in mind that conditions (e.g. rain, ice, loose gravel, slopes, soft ground etc. can change the response of your machine).

READ THE OPERATOR INSTRUCTION MANUAL BEFORE STARTING THE ENGINE. STUDY THE MANUAL BEFORE YOU START WORK. ALWAYS RETURN OPERATOR MANUAL TO HOLDER AFTER USE.



IF THERE IS SOMETHING IN THE MANUAL WHICH YOU DO NOT UNDERSTAND CONTACT THE MACHINE AGENT OR MANUFACTURER TO EXPLAIN IT TO YOU.

2. SAFETY NOTES

2.3 Danger, Warning and Caution

Whenever you see the words and symbols shown below, used in this manual and on machine decals, you **MUST** take note of their instructions as they relate to personal safety.



DANGER: This symbol together with the word ***DANGER*** indicates an imminently hazardous situation that, if not avoided, will result in **DEATH OR VERY SERIOUS INJURY**.



WARNING: This symbol together with the word ***WARNING*** indicates a potentially hazardous situation that if not avoided could result in **DEATH or SERIOUS INJURY**



CAUTION: This symbol together with the word ***CAUTION*** is used to indicate a potentially hazardous situation that, if not avoided, may result in **MINOR INJURY**.

2. SAFETY NOTES

2.4 Use All Available Protective and Safety Devices

Keep all protective devices in place and securely fastened. Make sure all guards, shields and safety signs are properly installed and are in good condition.

2.5 Checking the Equipment

Before you begin your working day, take time to check your machine and ensure that all systems are in good operational order.

- Check the engine oil level.
- DO NOT smoke while refuelling the equipment.
- Stop the engine and wait for it to cool before refuelling.
- DO NOT smoke while checking levels or changing engine oil or hydraulic oils.
- Keep any type of open flame away from machine
- Check for loose, broken, missing, or damaged parts. Have everything put into good repair. Make certain all safety devices are in place.
- Perform all maintenance procedures outlined for the equipment



WARNING: Fuel or hydraulic fluid under pressure can penetrate the skin or eyes and cause serious personal injury, blindness or death. Fluid leaks under pressure may not be visible. Use a piece of cardboard or wood to find leaks. DO NOT use your bare hands. Wear safety goggles for eye protection. If any fluid is injected into the skin, it MUST be surgically removed. See a doctor immediately.

Before applying pressure to the fuel or hydraulic system be sure all connections are tight and that lines, pipes and hoses are not damaged. Before disconnecting fuel or hydraulic lines, be sure to relieve all pressure.

Make sure that all hydraulic lines are correctly installed.



WARNING: Liquid engine cooling systems build up pressure as the engine gets hot. If your machine is fitted with a liquid cooled engine, then stop the engine and let the system cool before removing the radiator or filler cap.

2. SAFETY NOTES

2.6 Starting

2.6.1 Warn Personnel Before Starting

Before starting let other workers and bystanders, particularly children, know you are starting the machine and do not start until everyone is clear of the machine.

2.6.2 Start Safely



WARNING: Before starting the engine make sure there is plenty of ventilation. **DO NOT** operate the engine in a closed building. The exhaust fumes may cause asphyxiation.

2.6.3 Follow Recommended Starting Procedures

Follow the starting procedures recommended in the Engine Operation section of this manual.

2.6.4 Test the Controls

After starting, make sure everything is functioning correctly. If the machine does not respond correctly when each control is operated. **DO NOT** use the machine until the fault is rectified.

2.7 Work Safely



WARNING: An unbalanced machine could overturn and cause injury or death. Make sure to following the manufacturer's recommendations regarding load capacities. Be particularly careful when operating on uneven or sloped ground. Make sure to following the manufacturer's recommendations regarding stability on such terrain.

2. SAFETY NOTES

2.7.1 Making the Right Moves

Make sure your machine is ready for the job it must do. Know the rated capacities of your machine and never exceed them. Take extra care when operating on uneven, bumpy or sloping surfaces.

2.7.2 Follow Safe Operating Practices

- Operate the controls smoothly
- DO NOT attempt to operate the controls from a distance outside your normal reach
- DO NOT carry passengers
- DO NOT touch, lean on, or reach through any mechanisms on the unit or permit others to do so
- Lower the skip into transport position and shut off engine before leaving the machine

Stay alert. Should something break, come loose, or fail to operate on your equipment, stop work, lower equipment to the ground, shut off the engine, inspect the machine and have repairs or adjustments made before resuming operation.

2.7.3 Watch out for others

- Be aware of what is going on. DO NOT allow an untrained or unqualified person to operate the machine. They could injure themselves or someone else.



WARNING: This equipment is designed to be a one-person machine. DO NOT carry passengers. DO NOT allow children to operate the machine.

- Be certain you can control both speed and direction before moving. Move slowly until you are sure that everything is operating properly. After starting, recheck the steering, right and left. Be certain you have full steering and brake control.
- DO NOT lift a load over anyone
- Keep others away from your operation. Make sure they stand clear of the equipment
- DO NOT lift objects which cannot be contained securely in the bucket of the machine.
- When using the equipment, avoid sudden stops, starts, or changes of direction. Keep bucket in lowered position when transporting.
- DO NOT drive the equipment towards someone standing in front of a fixed object.

2. SAFETY NOTES

2.8 Safety Labels





SAFETY NOTES

The machine is fitted with a number of safety labels as shown on the previous page. Details are presented below on the hazard identified, the appraisal of the risks involved and the precautions to be taken.

Adhere scrupulously to the instruction provided and study them before first use of the machine:

- Before use study the manual and get acquainted with the information it contains and on the details regarding position and meaning of machine safety labels.
- Make sure all people who operate the machine are familiar with the information.
- Ensure all safety labels remain in place.
- Replace or clean illegible labels.
- Use a clean soft cloth with soapy water to clean labels.
- Do not use petrol or solvents to clean labels as it will cause adhesive to fail.
- If the label is located on a piece of the machine which has to be replaced then fix a new label to the replacement part.

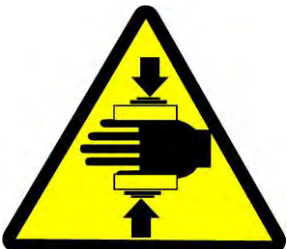
No.	SYMBOL	MEANING
1		<p>Element described Machine in motion</p> <p>Appraisal of risk Crushing or breaking of limbs</p> <p>Precautions Maintain safe distance</p>
2		<p>Element described Hot engine</p> <p>Appraisal of risk Possibility of burns</p> <p>Precautions Do not touch machine until engine has cooled</p>
3		<p>Element described Mechanism in motion</p> <p>Appraisal of risk Crushing or breaking of limbs</p> <p>Precautions Do not place limbs between chassis and skip</p>

SAFETY NOTES

2.9 Noise Level Label



Information on the acoustic survey for sound pressure required by Directive 2006/42/EC is provided on label A. As the threshold of 96dB(A) was recorded it is required to measure sound power and the details are provided on label B.

In many countries it is obligatory to equip yourself with ear protection when the limit of 96dB(A) is reached.

Depending on exposure it is advisable that operators and those in the vicinity use ear protection even in countries that do not comply with the Directive on noise.

3. GENERAL INFORMATION

3.1 Machine Description

The Slanetrac HT 1000 is a track-based machine designed to mechanise a range of material handling operations.

The features of the Slanetrac HT 1000 include:

- *Large load carrying capacity:* The unit can carry a payload of 1000kg.
- *Narrow operating width:* The unit is 750mm wide and this allows access to work areas normally inaccessible to such mechanised equipment.
- *High tip facility:* Pivot pin height is 1270mm which allows the “stacking” of tipped material or the transfer of material into other skips, bins or containers.
- *Automatic brakes:* For safety the unit stops as soon as the operators removes contact pressure from drive controls
- *Track drive system:* The drive system allows the unit to operate in conditions of wet or poor terrain. Fully laden ground contact pressure is 0.48 kg/cm².
- *Power unit:* The unit is powered by a reliable Honda GX390 petrol engine.

3. GENERAL INFORMATION

3.2 Functional Elements on the Slanetrac HT 1000

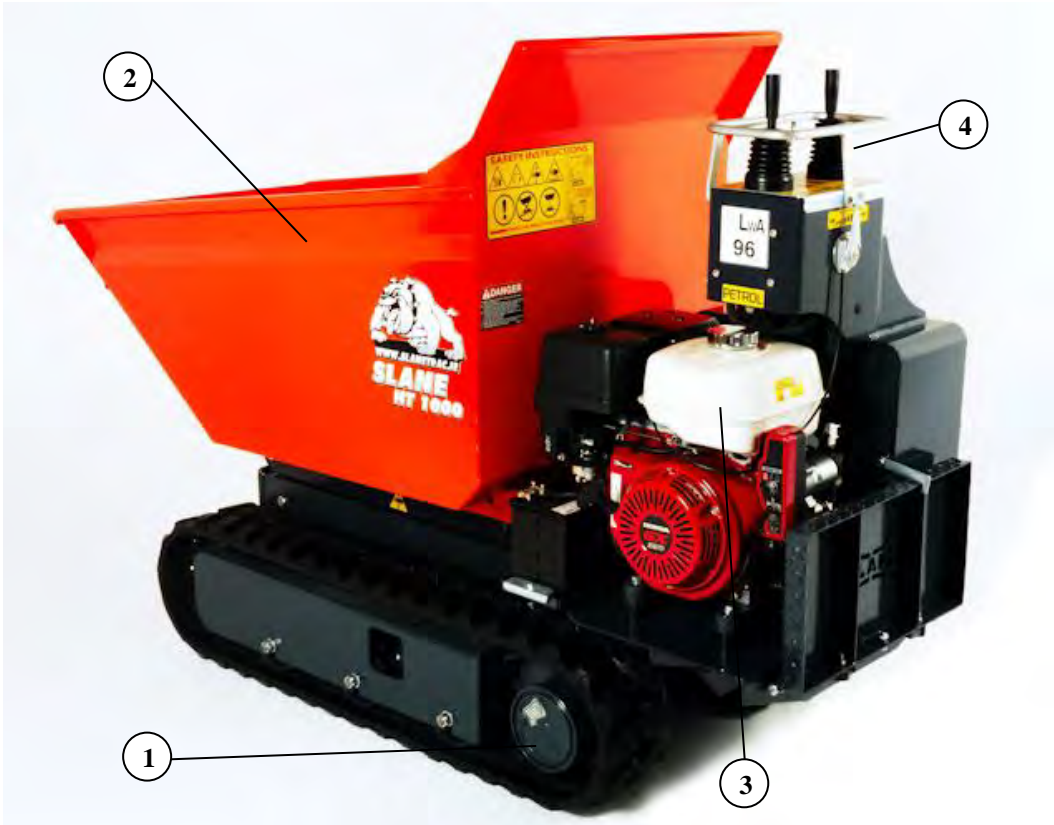

Position	Description
1	Drive system
2	Skip
3	Engine
4	Hydraulic system

3. GENERAL INFORMATION

3.2.1 DRIVE SYSTEM

The drive is of the hydraulic type. There are two independently driven track motors. These are used for forward, reverse, right turn or left turn depending on the position selected for the two control levers. When the levers are in the neutral position the drive system is locked in position which prevents movement. The tracks used are made of rubber to minimise ground damage.

3.2.2. SKIP

The load skip or hopper is fabricated from steel plate. It has a level filled capacity of 400litres and a peaked filled capacity of 500litres. The unit incorporates a “high-tip” mechanism. This allows the skip to be either tipped directly or raised vertically to a pivot pin height of 1270mm before tipping. Both the tipping function and the high lift functions are operated by hydraulic cylinders.

3.2.3. ENGINE

The engine is a Honda GX390 petrol powered unit. This air-cooled compact engine is direct coupled to the hydraulic pump unit and so no belts or gears are required. Full details on the unit are available in the accompanying Honda manual.

3.2.4. HYDRAULIC SYSTEM

The hydraulic system comprises five principal elements:

- Hydraulic oil reservoir
- Hydraulic pumps (2 in combination)
- Hydraulic controls
- Hydraulic filters (1)
- Hydraulic cylinders (2)
- Hydraulic track drive motors (2)

4. TECHNICAL SPECIFICATION

4.1 MACHINE DIMENSIONS – WEIGHT – CONTACT PRESSURE

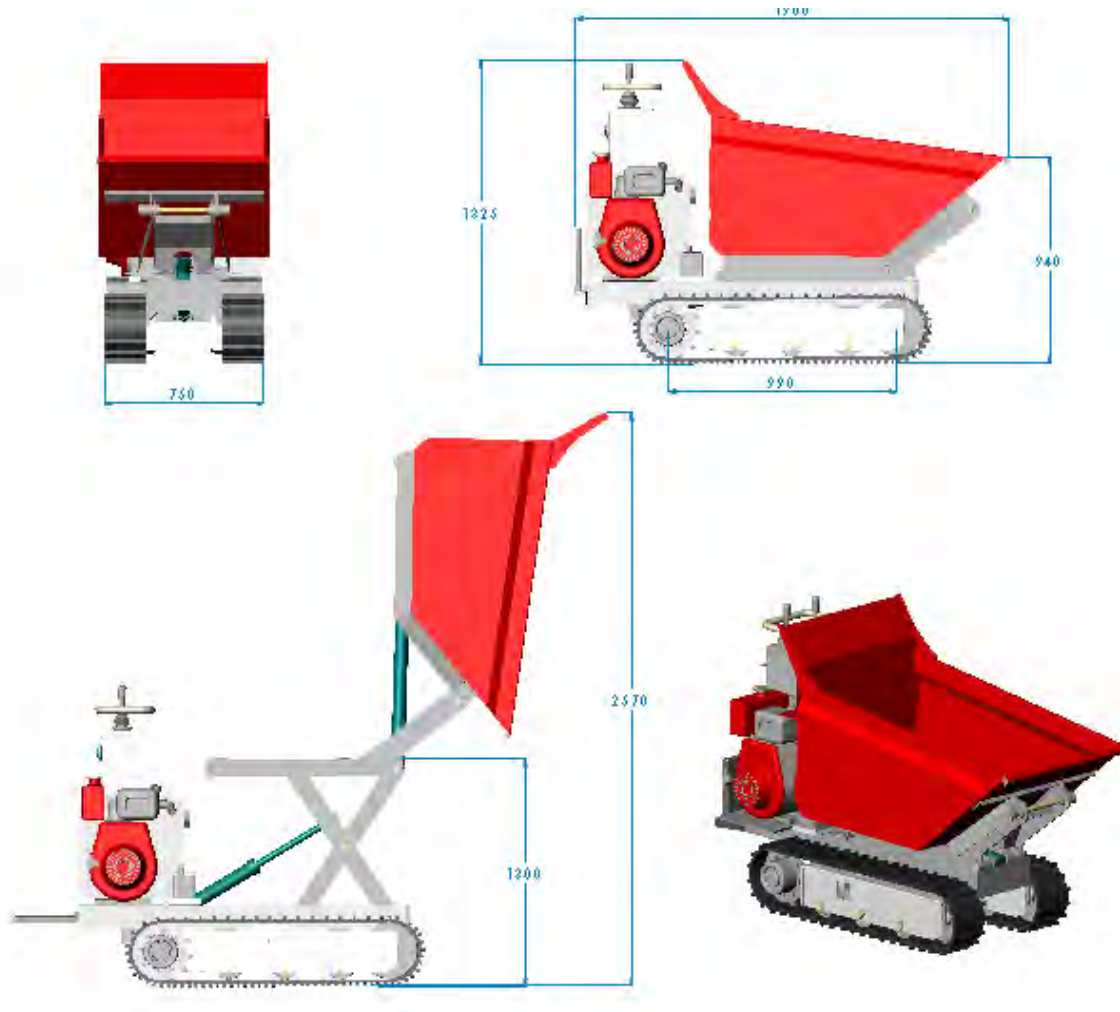

Unladen Machine	
Weight	Contact Pressure
600 kg	0.25 kg/cm ²

Ladened Machine	
Weight	Contact Pressure
1600 kg	0.55 kg/cm ²

4. TECHNICAL SPECIFICATION

4.2 MACHINE STABILITY

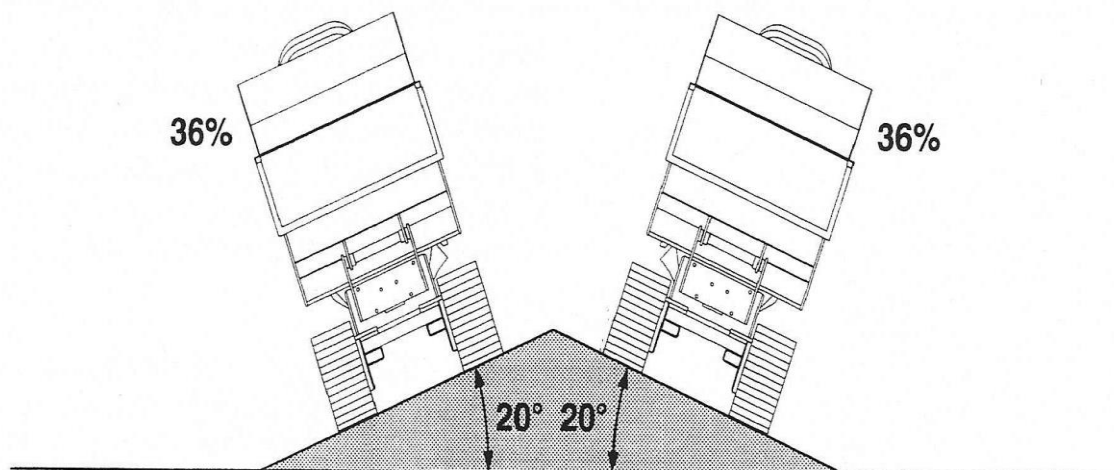
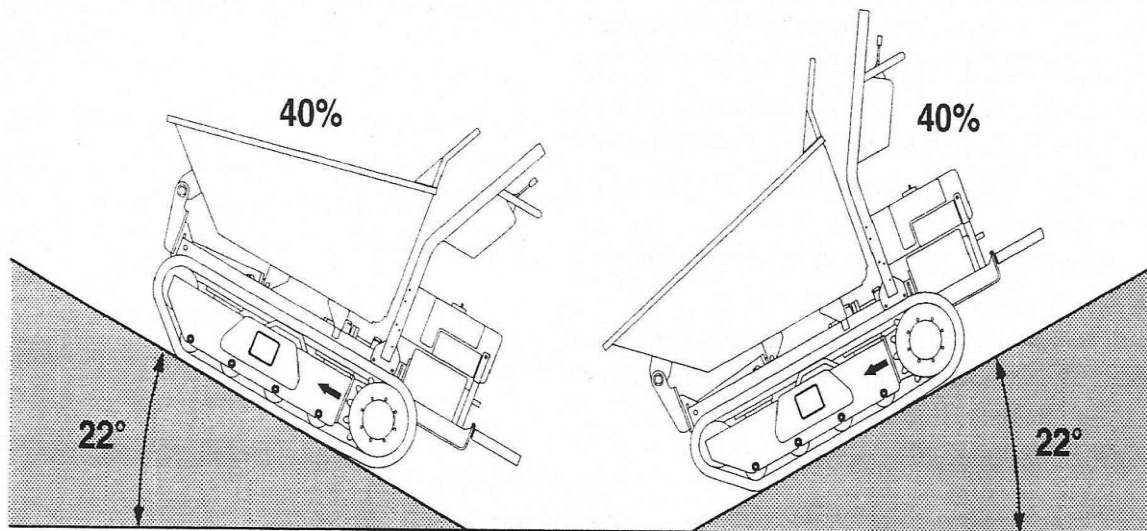

The machine can climb and decent slopes of 40% (22^o) with a stable packed load. The machine can move on cross slopes of 36% (20^o). Note at all time during transport the skip must be in the fully lowered position.

When using the “scissors” skip raising mechanism the machine must be on level ground.

During all tipping operations the machine must be on level ground.

4. TECHNICAL SPECIFICATION

4.3 TECHNICAL DATA

4.3.1 ENGINE

Make	HONDA
Model number	GX 390
Type	4-stroke, overhead valve
Fuel	Petrol
Cylinder number	One
Displacement	406 (24.8)
Bore X stroke	86 X 70
Max. power	13 HP @ 3600 rpm
Cooling System	Forced air
Starting System	Electric starting
PTO shaft rotation	Counter clockwise

4.3.2 HYDRAULIC SYSTEM

Number of pump units	2
Make	Cassapa
Capacity	6.2 X 2
Operating pressure	160 bar
Number of hydraulic motors	2
Make	ORBITAL
Capacity	100 cc

4. TECHNICAL SPECIFICATION

4.4 PERFORMANCE IN WORK

Skip capacity (peak filled)	400 litres
Skip capacity (level filled)	500 litres
Maximum operating slope with stable packed load (transverse direction)	36%
Maximum operating slope with stable packed load (longitudinal direction)	40%
Maximum payload	1000 kg
Velocity (forward)	1.5 – 4.5 km/h
Velocity (reverse)	1.5 – 4.5 km/h

5. MACHINE CONTROLS





5.1 Hydraulic Controls





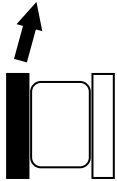

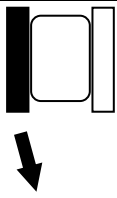
1



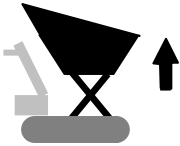



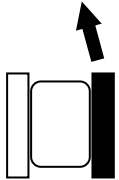

2

5. MACHINE CONTROLS

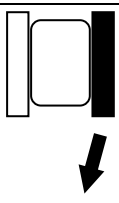

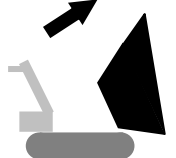
LEVER	DESCRIPTION	SYMBOL	MOVEMENT	FUNCTION
1	Single lever operation			Turning to the right in the forward direction (with right side track stationary)
				Neutral
				Turning to the right in the reverse direction (with right side track stationary)

LEVER	DESCRIPTION	SYMBOL	MOVEMENT	FUNCTION
1	Single lever operation			Raise skip
				Neutral
				Lower skip

5. MACHINE CONTROLS

LEVER	DESCRIPTION	SYMBOL	MOVEMENT	FUNCTION
2	Single lever operation			Turning to the left in the forward direction (with right side track stationary)
				Neutral
				Turning to the left in the reverse direction (with right side track stationary)
2	Single lever operation			Raise skip
				Neutral
				Lower skip

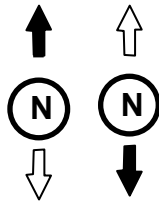
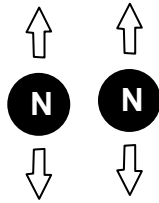
5. MACHINE CONTROLS

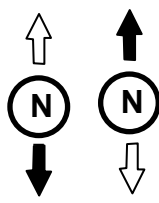
1- 2	Combined lever operation			Clockwise rotation (around centre axis of machine)
				Neutral
				Anticlockwise rotation (around centre axis of machine)

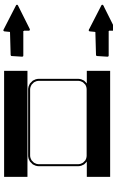
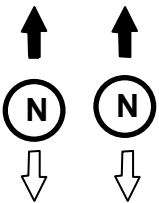
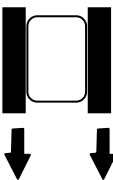
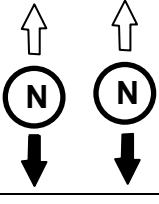
LEVER	DESCRIPTION	SYMBOL	MOVEMENT	FUNCTION
1- 2	Combined lever operation			Movement in forward direction
				

6. USER INSTRUCTIONS

6.1 OPERATION OF MACHINE



DANGER: Do not carry passengers on the machine.

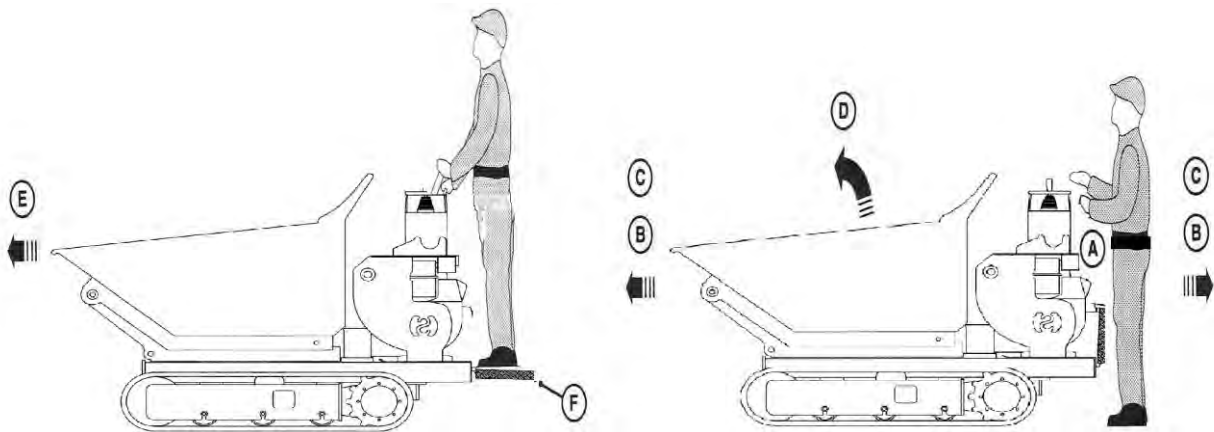

When the machine is in motion a stand-on platform, F, is provided for the operator. When using the high lift and tip functions the operator must stand on the ground. **If the operator is not standing on the ground when performing the tipping function, the machine will not tip.**

The operator is responsible for ensuring the machine is not overloaded or loaded in an unstable manner or positioned on unsafe slopes by following the information provided in the Technical Specification section of this manual.



6. USER INSTRUCTIONS

6.2 Engine Operation

A separate engine manual is provided with full details for engine operation and maintenance.

6.3 Skip Operation (Raising & Tipping)



DANGER: The operator must ensure during raising and tipping of the skip that they do not come in contact with the moving parts and mechanisms on the machine.



DANGER: The operator must ensure that all co-workers and other by-standers are far enough away from the machine so that they cannot come in contact with the moving parts and mechanisms on the machine.



DANGER: The operator must ensure that all co-workers and other by-standers are far enough away from the machine so that they cannot come in contact with the moving parts and mechanisms on the machine.

6. USER INSTRUCTIONS

6.4 Transport

It may be necessary for the machine to be transported between working locations. If a road vehicle or trailer is being used ensure that it is of sufficient load carrying capacity and dimensions for the machine. If loading ramps are being used ensure these are designed to carry the weight of the machine during loading and unloading. The machine must be secured to the base of the transporting vehicle by suitable straps or chains shackled too the eyes (see next page) on the undercarriage. The target angle of any loading ramp should be approximately 18° or less. The accompanying figures show suitable dimensions for the height of the transporting vehicle load bed and length of the loading ramp.

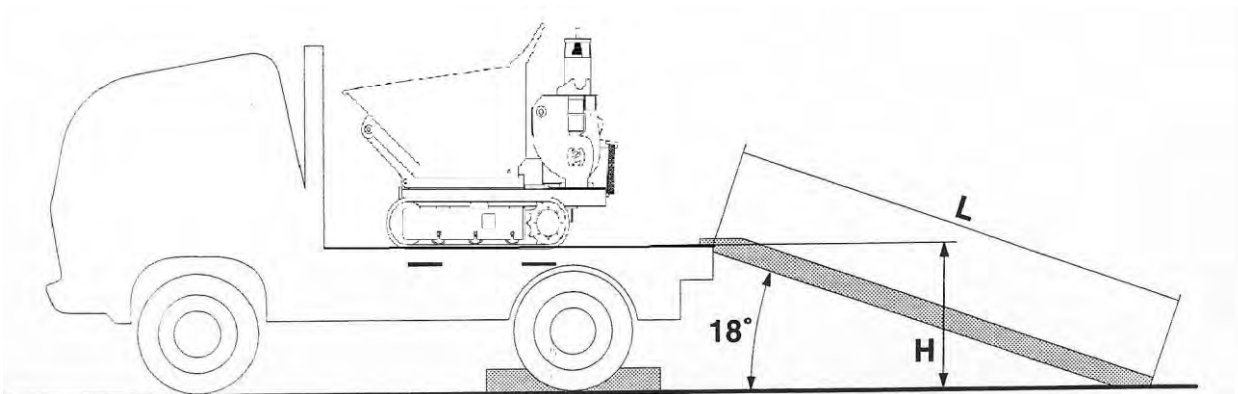

H (mm)	L (mm)
766 to 996	3000
1035 to 1235	4000

6. USER INSTRUCTIONS

6.5 Lifting of Dumper.

It may be necessary for the machine to be lifted to gain access into working locations and transportation. If truck mounted Hiab or mobile crane are being used ensure that they have a sufficient lifting capacity designed to lift the weight of the dumper and lifting certification is in date.

Make sure that all straps and shackles being used are in good condition and are rated for the load capacity and are in date.



7. MACHINE MAINTENANCE

7.1 INTRODUCTION TO SERVICING



WARNING: When carrying out service and maintenance operations on your machine it is important to follow some basic guidelines including:

- ◆ **DO NOT** service the machine with the engine running.
- ◆ **DO NOT** work beneath the machine unless proper supporting stands are used. **DO NOT** work on this machine without the ram safety struts in place.
- ◆ Ensure inadvertent movement of hydraulic cylinders will not trap you or cause injury during servicing.
- ◆ Wear appropriate protective clothing.
- ◆ Keep hands, tools and items clear of all moving parts. Avoid contact with the exhaust pipe and manifold. They may be hot and cause burns.
- ◆ Before changing oil use a suitable barrier cream on your hands.
- ◆ Wash off dirty oil with soap and water as soon as you have finished changing the oil. Contaminated clothing must be removed and cleaned.
- ◆ Prolonged contact with dirty oil may affect your health; therefore, it is important that you follow the above instructions.
- ◆ Keep children and pets clear of the machine. **DO NOT** allow anyone near the machine unless specifically working to your instructions.

USE APPROVED LUBRICANTS AS SPECIFIED IN THIS MANUAL

7. MACHINE MAINTENANCE

7.1 INTRODUCTION TO SERVICING

Always ensure that safety struts are used while maintaining or carrying out work on the hydraulic system of the HT1000S.

The safety struts are located on the underside of the skip.



7. MACHINE MAINTENANCE

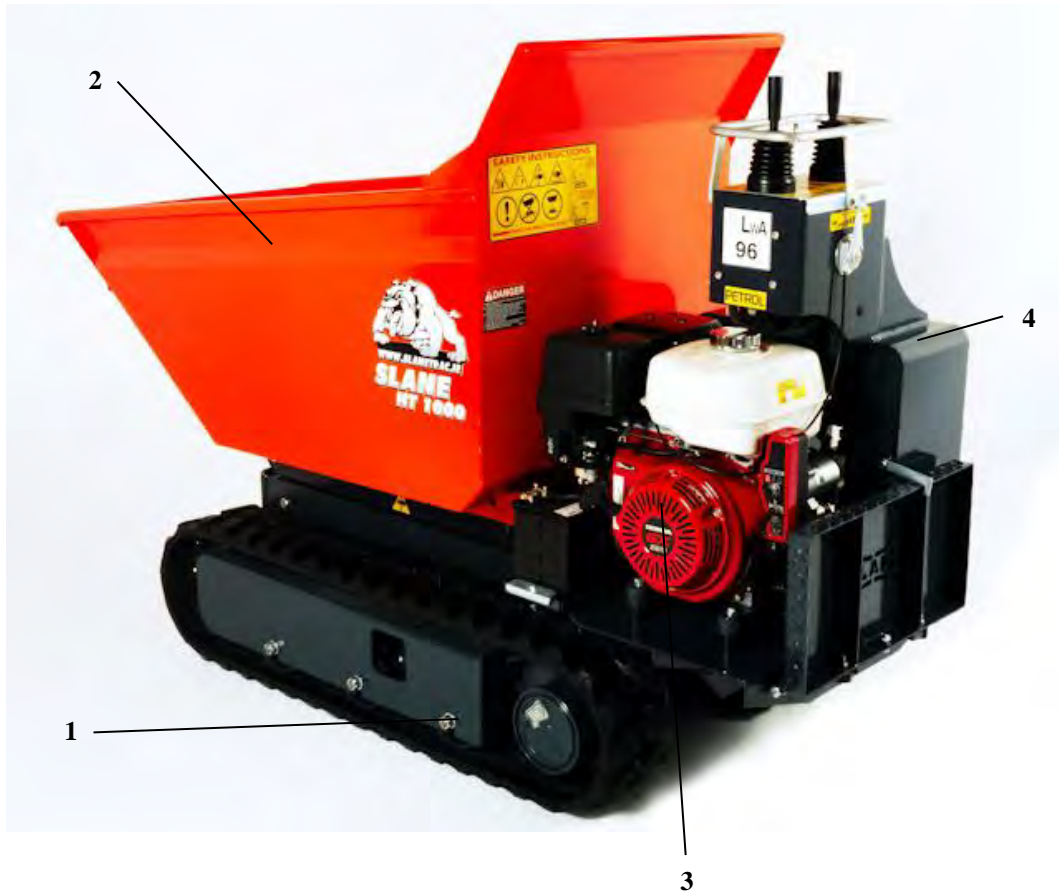

Position	Description	Subsection
1	Drive system	7.2
2	Skip	7.5
3	Engine	7.3
4	Hydraulic system	7.4

7. MACHINE MAINTENANCE

7.2 TRACKS

7.2.1 Track Tension: It is important to have the correct tension on the crawler tracks. Incorrect tension will cause premature wear of components. Different levels of tension between right and left tracks will hinder straight line movement of the machine. To check the tensions, proceed as follows (see accompanying figure):

Checking the tension

- Position the machine on level ground.
- Raise the machine and provide suitable support.
- Measure the distance H between the roller A and the top of the metal insert in the track B.
- The distance should be 10 – 15 mm, if it is not within this range adjust as shown below.

Adjusting track tension

- With the machine raised loosen the locknut at C
- Adjust the tension of the spring using the adjusting nut until distance H is within tolerance.
- Retighten the locknut.

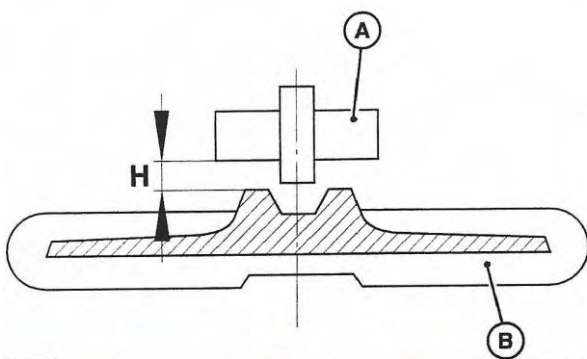

	Check EVERY 200 HOURS
	Adjust WHEN NECESSARY

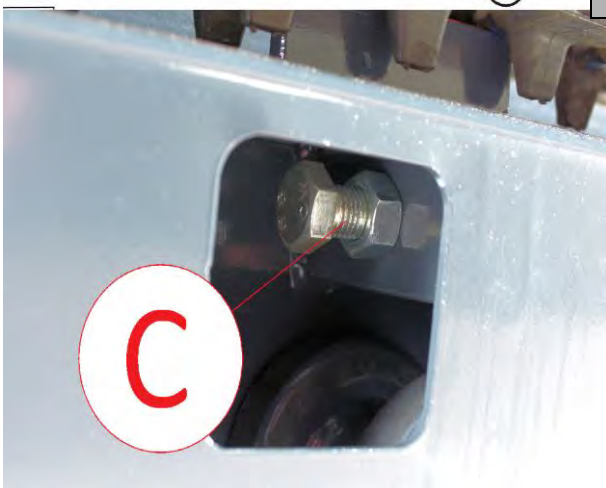

7. MACHINE MAINTENANCE

7.2.2 Check Idler Rollers: The idle rollers, A, are chosen to be “lubricated for life”. Under normal operating conditions they do not require maintenance. However, periodic inspection is recommended to ensure the rollers are functioning optimally. They may be damaged if working under arduous conditions or through accidental aggressive use of machine. If there are signs of lubricant leakage, then the roller should be replaced.

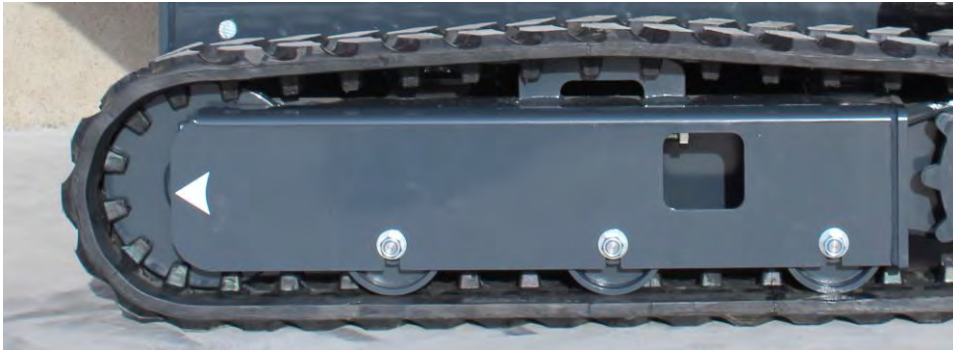

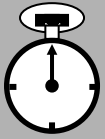
	<p>Check</p> <p>EVERY 200 HOURS</p>
--	--

7. MACHINE MAINTENANCE

7.3 ENGINE (HONDA GX390)

7.3.1 Oil Level:

- Running the engine with insufficient oil will cause serious engine damage.
- Be sure to check the engine on a level surface with the engine stopped.

Checking oil level and topping up oil level

1. Remove the oil filler cap, A, and wipe the dipstick clean with a clean, dry cloth.
2. Insert the dipstick into the oil filler neck, but do not screw it in.
3. If the level is low, fill to the top of the oil filler neck with the recommended oil.

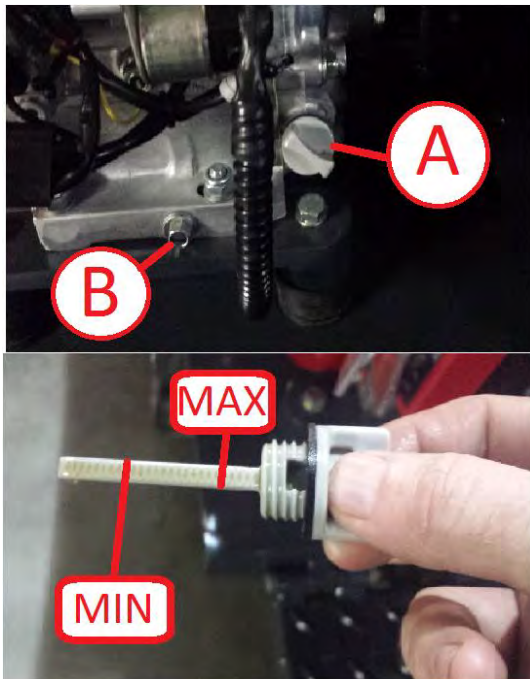

	Check oil level and top-up EVERY 10 HOURS
	First change AFTER 50 HOURS
	Normal oil change interval EVERY 200 HOURS

Changing the oil

Drain the oil while the engine is still warm to ensure rapid and complete draining.

- Position machine on level ground.
- Place suitable oil collection tray under bung B.
- Remove the filler cap, A, and drain bung, B.
- Allow oil to drain out through B.
- Close bung B and refill with oil through bung A (see sections in this manual dealing with approved lubricants and capacities).
- Close bung A.

For other engine service requirements consult the accompanying HONDA manual.

7. MACHINE MAINTENANCE

7.4 HYDRAULIC SYSTEM

7.4.1 Oil: The hydraulic system provides oil under pressure for operating track drives and hydraulic cylinders. Take care when servicing the hydraulic system and ensure there is no residual pressure in the system before carrying out any maintenance or servicing functions.



WARNING: Hydraulic fluid under pressure can penetrate the skin or eyes and cause serious personal injury, blindness or death. Fluid leaks under pressure may not be visible. Use a piece of cardboard or wood to find leaks. **DO NOT** use your bare hands. Wear safety goggles for eye protection. If any fluid is injected into the skin, it **MUST** be surgically removed. See a doctor immediately.

Checking oil level and topping up oil level

- Position the machine on level ground.
- Check that the oil level is visible at inspection point A.
- Remove filler cap B and add approved oil to the correct level.
- Replace filler cap B.

Changing the oil

Drain the oil while the system is still warm to ensure rapid and complete draining.

- Position machine on level ground.
- Place suitable oil collection tray under bung C.
- Remove the filler cap, B, and drain bung, C.
 - Allow oil to drain out through C.
 - Close bung C and refill with approved oil through B.
 - Close bung B

	Check oil level and top-up EVERY 100 HOURS
	Hydraulic oil change interval Every 500 HOURS

7. MACHINE MAINTENANCE

7.4.2 Filtration System: The hydraulic oil filtration system comprises a paper element filter located in the return line to the hydraulic reservoir.

Changing the filter (paper element type)

- Remove the screws, A.
- Remove the cover, B.
- Remove the filter element, C.
- Replace new filter element.
- Replace cover, B.
- Tighten screws, A,
- Check oil level.

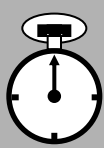

	First change 50 HOURS
	Normal change interval Every 500 HOURS

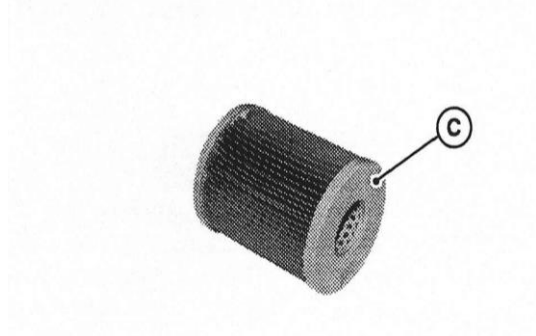

7. MACHINE MAINTENANCE

7.5 SKIP HIGH-LIFT & TIPPING MECHANISMS

The skip high-lift and tipping mechanisms are operated by two hydraulic cylinders. There are two greasing points on each cylinder as shown in the figure and these should be greased every 50 hours with approved grease.

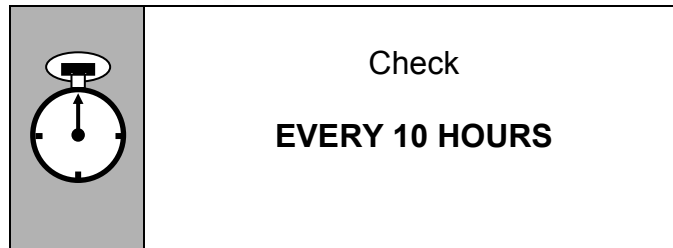

7. MACHINE MAINTENANCE

7.6 APPROVED FUEL, OILS AND LUBRICANTS

Make of Lubricant	Operating Temperature			
	-20 ⁰ C/+5 ⁰ C	+5 ⁰ C/+30 ⁰ C	+30 ⁰ C/+50 ⁰ C	-30 ⁰ C/+65 ⁰ C
AGIP	Blasia 100	Blasia 150	Blasia 320	Blasia S 220
ARAL	Degol BG 100	Degol BG 150	Degol BG 320	Degol GS 220
BP	GR XP 100	GR XP 150	GR XP 320	Energol HTX220
CASTROL	Alpha MAX 100	Alpha MAX 150	Alpha MAX 320	Alphasyn PG 150
ESSO	Spartan EP 100	Spartan EP 150	Spartan EP 320	Excolub SLG
Q8	Goya 100	Goya 150	Goya 320	El Greco 220
I.P.	Mellana 100	Mellana 150	Mellana 320	Telesia oil 150
MOBIL	Mobilgear 627	Mobilgear 629	Mobilgear 632	Glygoyle 22
SHELL	Omala oil 100	Omala oil 150	Omala oil 320	Tivela Oil SA
TOTAL	Carter EP 100 N	Carter EP 150 N	Carter EP 320 N	-
ELF	Reductelf SP 100	Reductelf SP 150	Reductelf SP 320	Elf Oritis 125MS

7.6.4 HYDRAULIC OIL

Use a high grade hydraulic oil with viscosity rating 46 HVI Hydraulic oil and meeting or exceeding specifications API GL4 ISO 32/46 MIL-L-2105 D.

7.6.5 GREASE

Use a multi-purpose lithium-based grease (e.g. BP-Mobilux EP2; CASTROL-Multifak All Purpose EP2; ESSO – Multis EP2) or equivalent from other manufacturers.

7. MACHINE MAINTENANCE

7.7 CAPACITIES

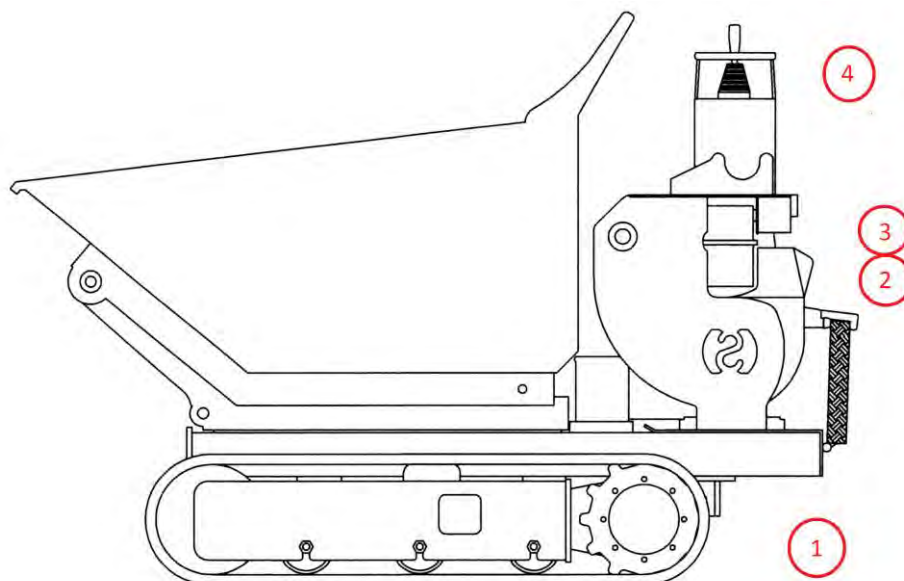

USE APPROVED OILS & LUBRICANTS AS SPECIFIED IN THIS MANUAL

Pos.	Description	Product	Capacity (litres)
1	Fuel tank	Petrol	4.7
2	Engine	15W40 Engine oil	1.65
3	Hydraulic reservoir	46 HVI Hydraulic oil	30

7.8 HANDLING OF WASTE OILS AND FILTER ELEMENTS

Care should be exercised when disposing of waste oils and filter components. These materials should not be disposed of through the domestic waste collection service. Use approved recycling organizations and adhere to any local legislation regarding the management of such materials.

7. MACHINE MAINTENANCE

Appendix – MAINTENANCE SCHEDULE

Every 10 Hours or daily

- Check engine oil level
- Grease points indicated on machine.

First 50 Hours

- Change oil in track drives
- Change hydraulic filter (paper element)
- Change engine oil and filter.
- Change fuel filter.
- Check and clean air filter.
- Check battery terminals.

Every 50 Hours

- Check high-lift and tipping mechanism
- Clean/change engine air filter.
- Check hydraulic pipes for wear and tear.

Every 250 Hours

- Change oil in track drives
- Check track drive tension
- Check track idler rollers
- Check/adjust valve clearance on engine
- Change engine oil and filter.
- Change air filter.
- Check water level in battery.

Every 500 Hours

- Change hydraulic oil
- Change hydraulic filter (paper element).
- Repeat of 200hr service.



Slanetrac Engineering Ltd

Dean Hill, Hayes, Navan, Co. Meath, Ireland.

EC Declaration of Conformity

We, Slanetrac Engineering Ltd of,

Dean Hill,
Hayes,
Navan,
Co. Meath,
Ireland.

Make: Slanetrac
Type: HT1000
Serial Number:
Description: Track Dumper

Is in conformity with the relevant clauses of the;

2006/42/EC Machinery Directive
2004/108/EC EMC Directive

And has been designed and manufactured according to the relevant clauses the following transposed harmonized European Standards and technical specification(s):

EN ISO 12100:2010
EN 474-1 :2007+A3:2013
EN 474-6 :2007+A1:2009

I hereby declare that the equipment named above has been designed to comply with all relevant essential requirements of the directive(s).

The undersigned, contactable at the address listed above, is the person authorized to compile the technical documentation in accordance with part A of Annex VII of Directive 2006/42/EC. The undersigned is established in the community.

Signed:

Name:

Position:

Signed at (place):

On (date):

